

Lifter

Step-by-step assembly instructions

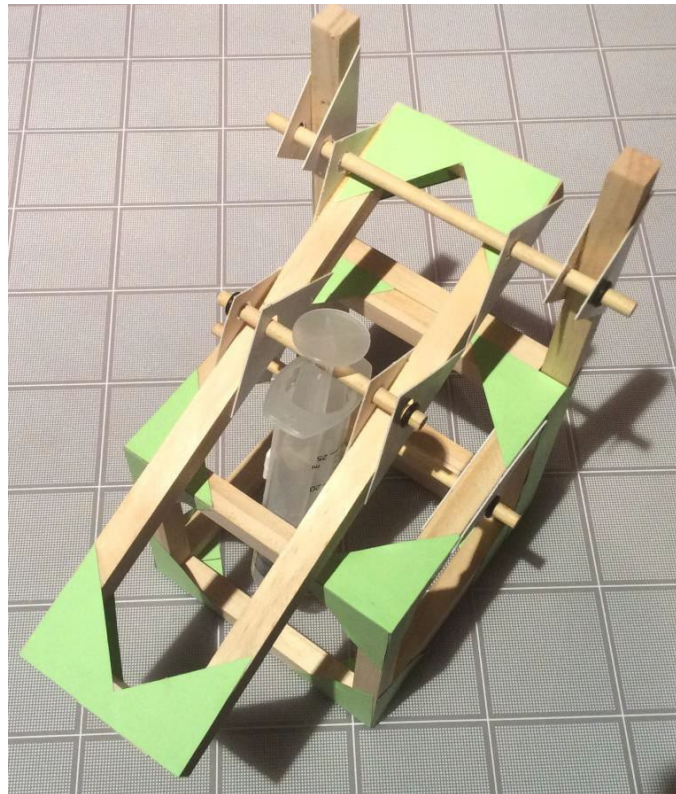

Contents of the Lifter Kit

Wooden pieces (1 cm cross-section): 8 X 92mm; 6 X 83mm; 4 X 203mm;
2 X 38mm; 3 X 25mm

Wooden dowel, 5mm diam.: 2 X 127mm; 1 X 76mm

Syringes, 20cc: 2 (1 has a hole in the plunger)

Plastic Tubing: 1 length

Green corner gussets: 2 cards

Axle Holders: 16

Syringe Holder: 1

Mini-washers: 8

Stirring Sticks for spreading glue: 2

Plus a small piece of sandpaper

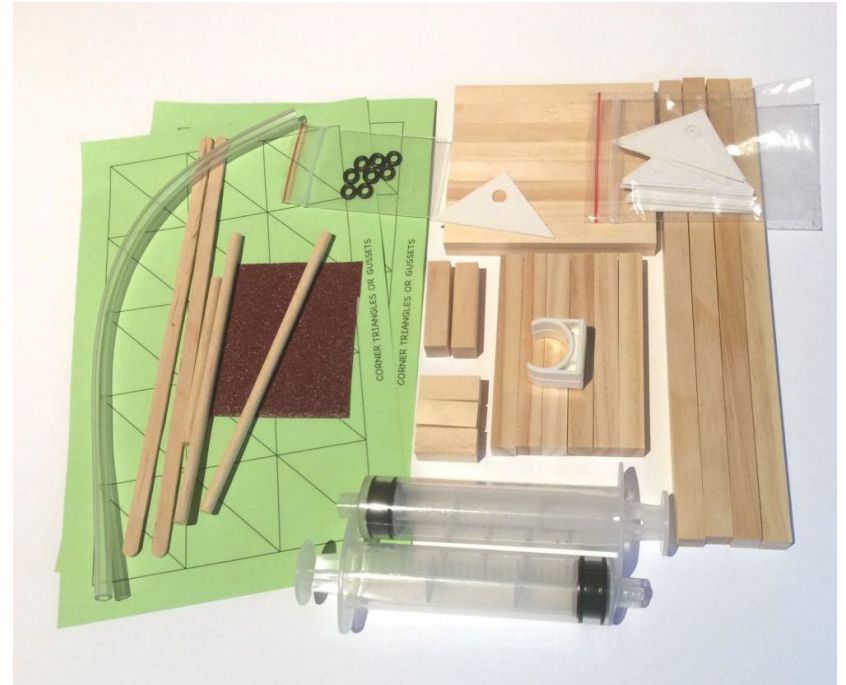

First, make a 102mm cube

You will need 8 X 92mm pieces and 4 X 83mm pieces.

First make two squares using 4 X 92mm pieces for each.

These images show the first steps involved in making the cube. Note how the pieces are set out

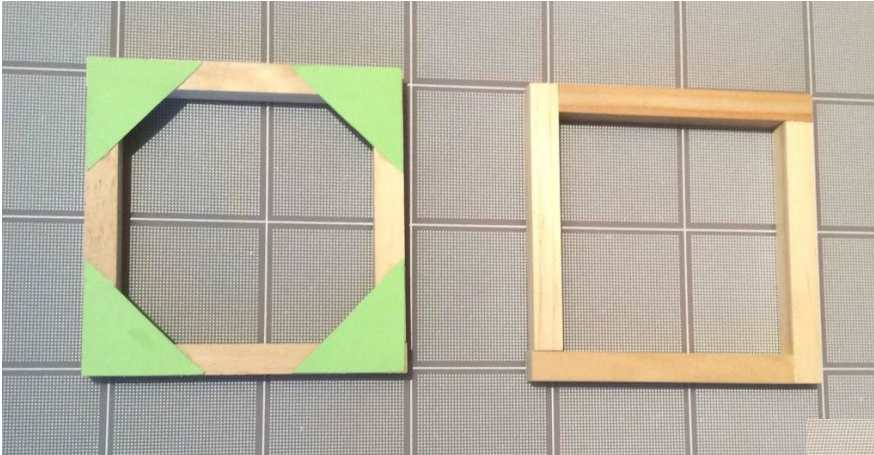

Gluing techniques:

Use sparing amounts of glue.

Use craft stick to spread a thin layer of glue at all joints.

Division of labor example:

WORKING IN GROUPS OF 3 OR 4?

One/Two person(s) can move to page 13 and construct the small platform and the arm

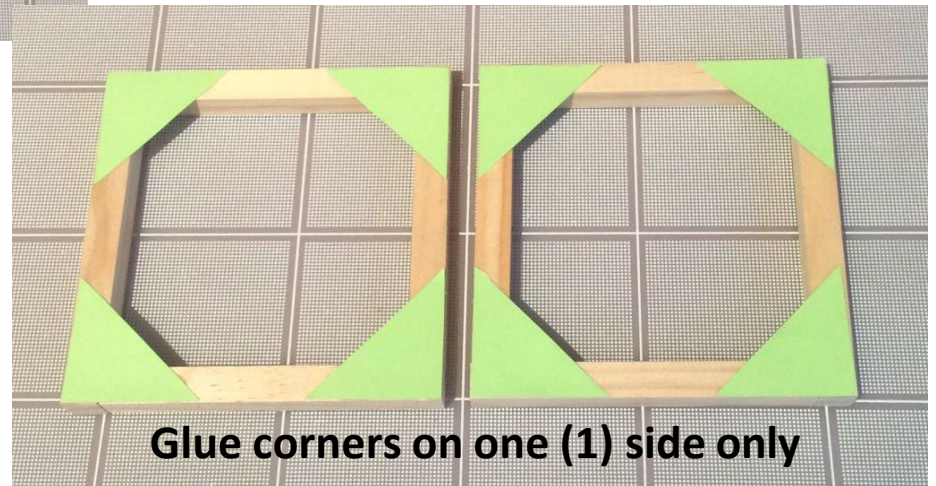

Glue corners on one (1) side only

Just in case your team needs help making the cube

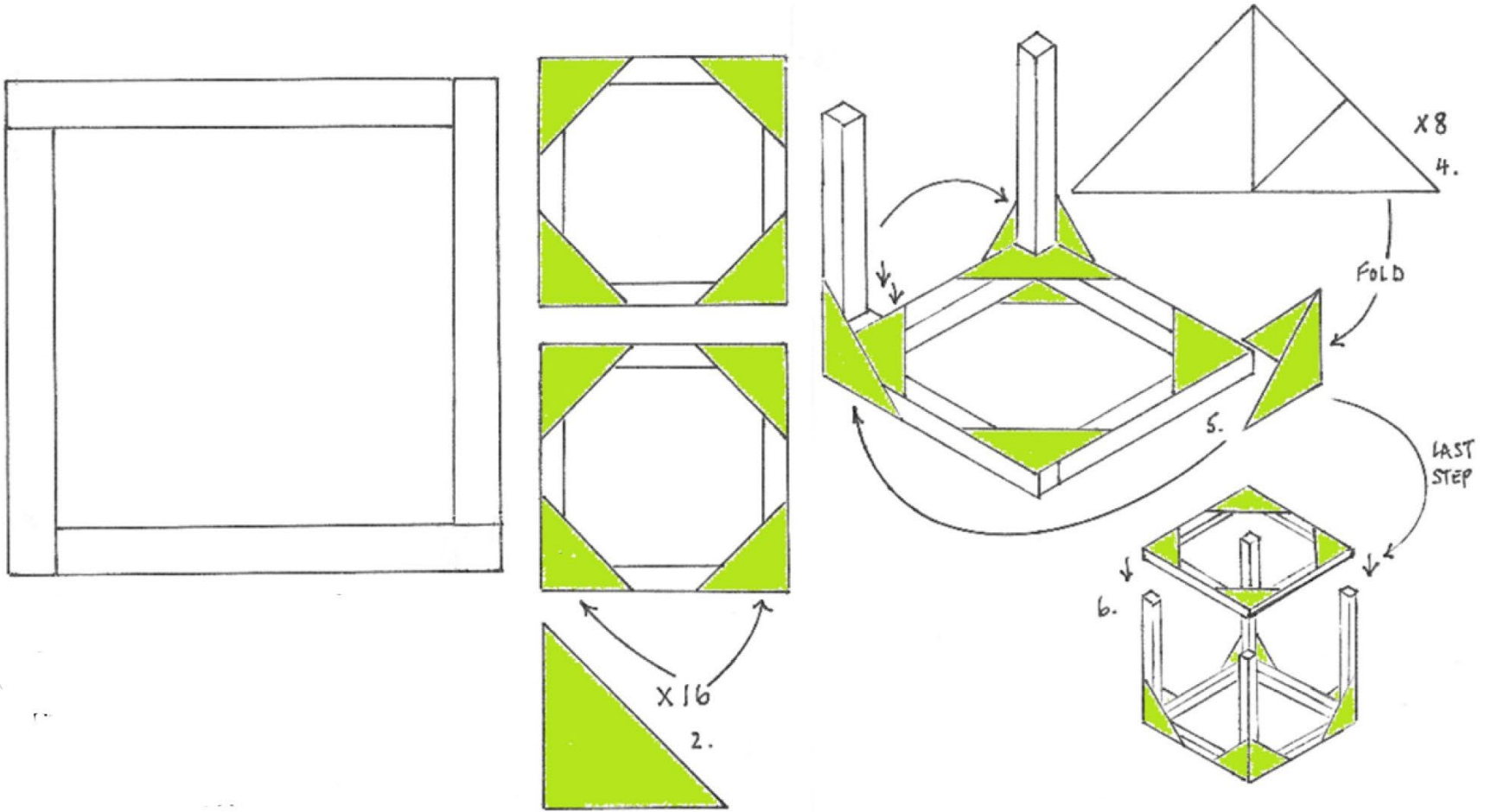

Add uprights and cap to finish the cube

Attach four 83mm pieces as uprights to each corner of the square base using double-sized green triangular gussets and then put the second square on top of the uprights (gusset side up) and attach it at the corners using similar double gussets.

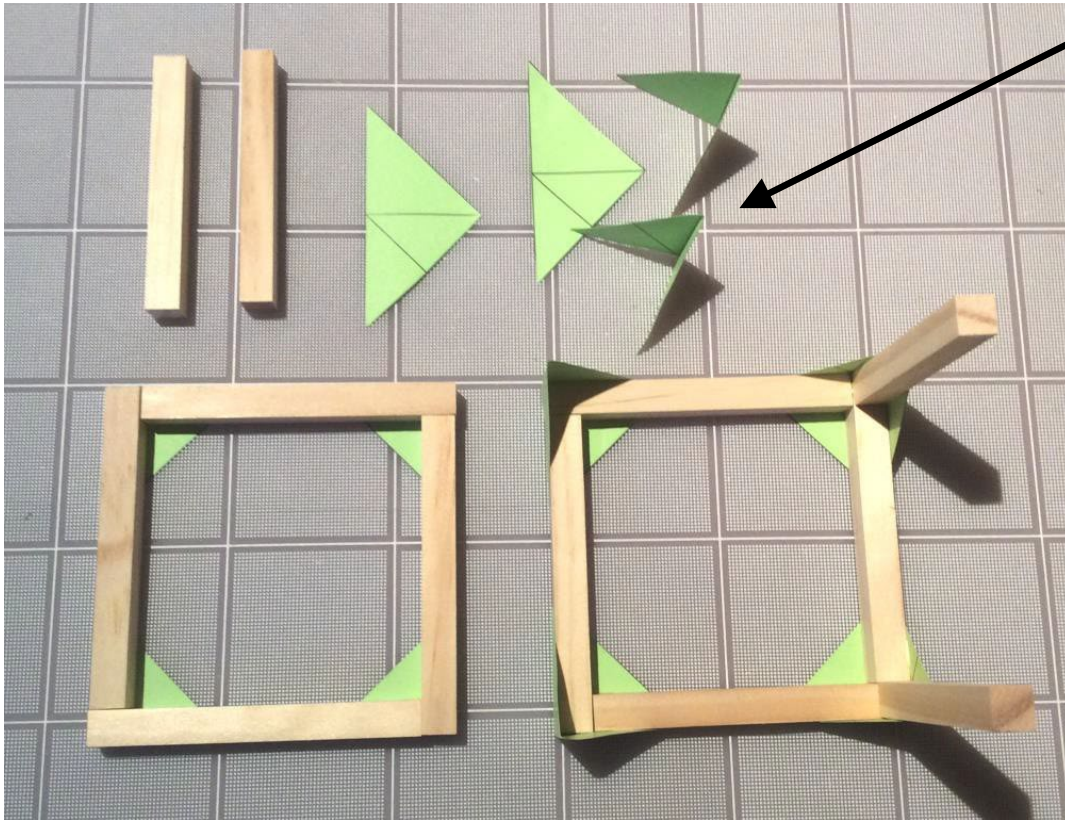

Double-sized triangular gussets

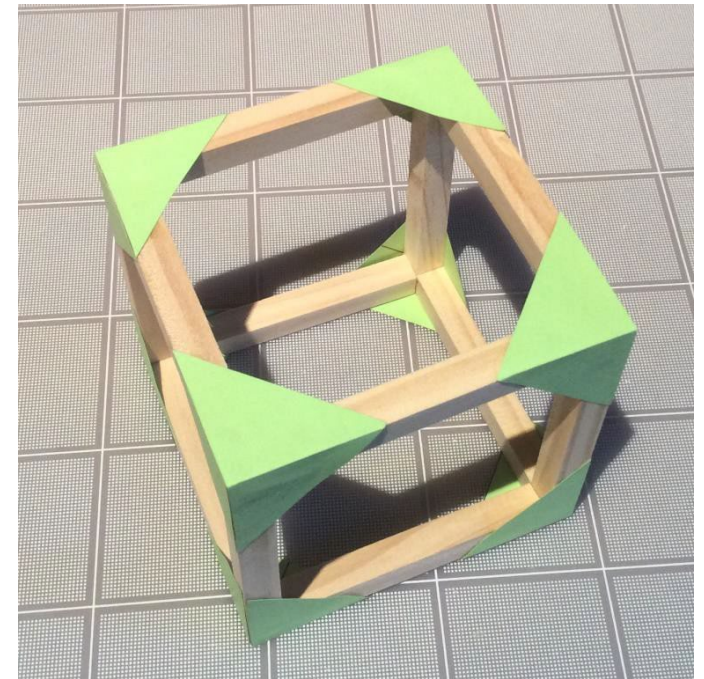

Adding two long uprights to the cube

Glue two 203mm pieces to one side of the cube. Reinforce by gluing two gusset strips 101mm X 19mm (cut from the green card) on the side as shown.

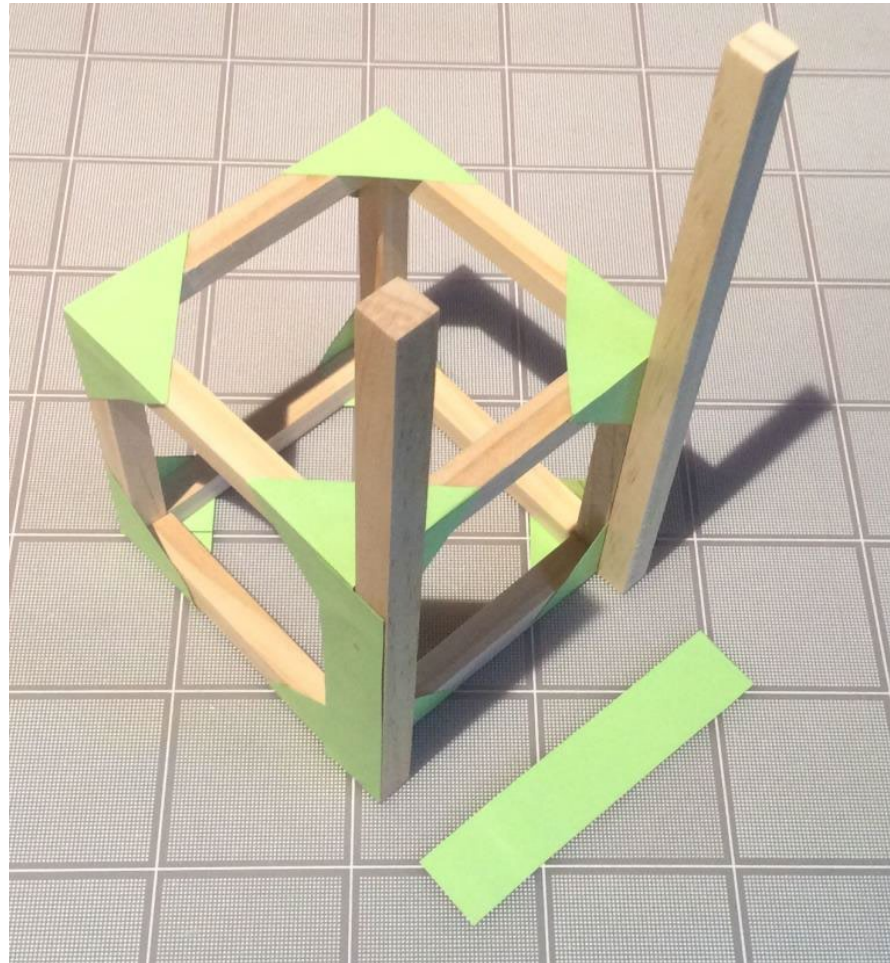

Reinforce the long uprights

Glue two 83mm pieces between the long uprights where shown and reinforce with four green triangular gussets.

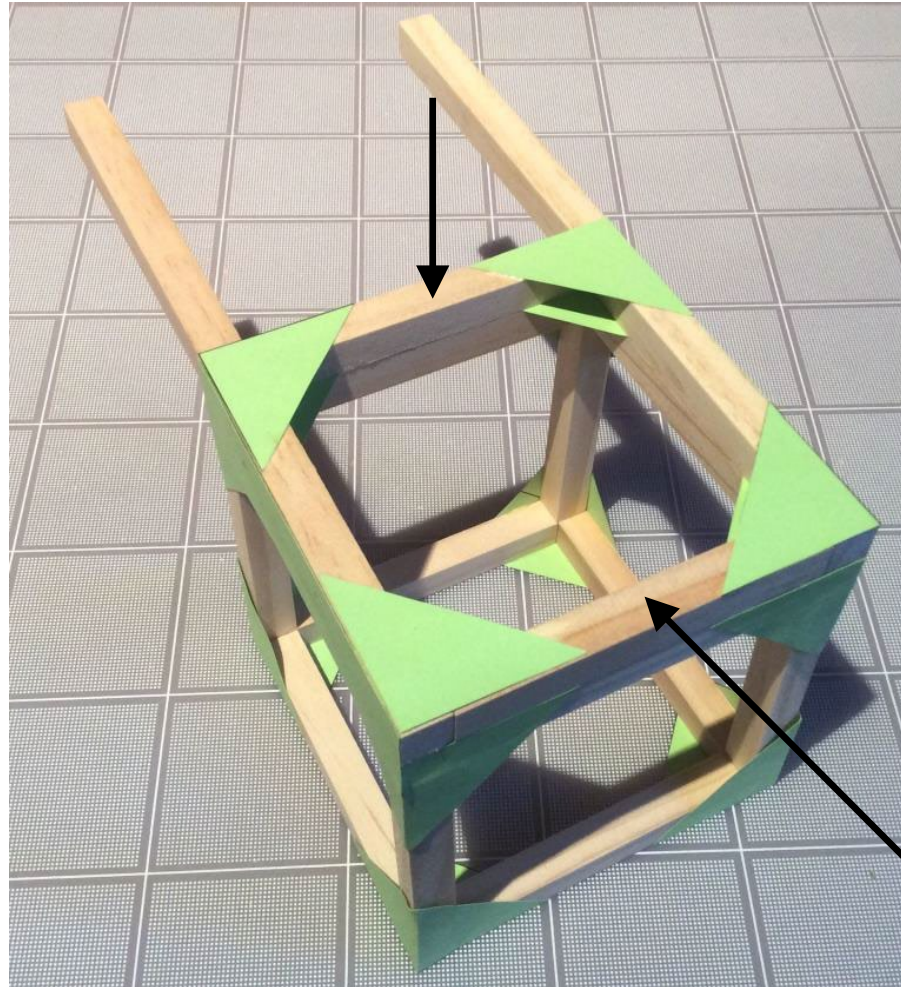

Adding the axle holder

Glue an axle holder onto the outside of the top of the cube as shown. Mark the centre of the axle holder and mark 64mm from the edge furthest from the uprights. Glue the axle holder into position, checking it is horizontal and parallel to the 83mm piece you glued in last.

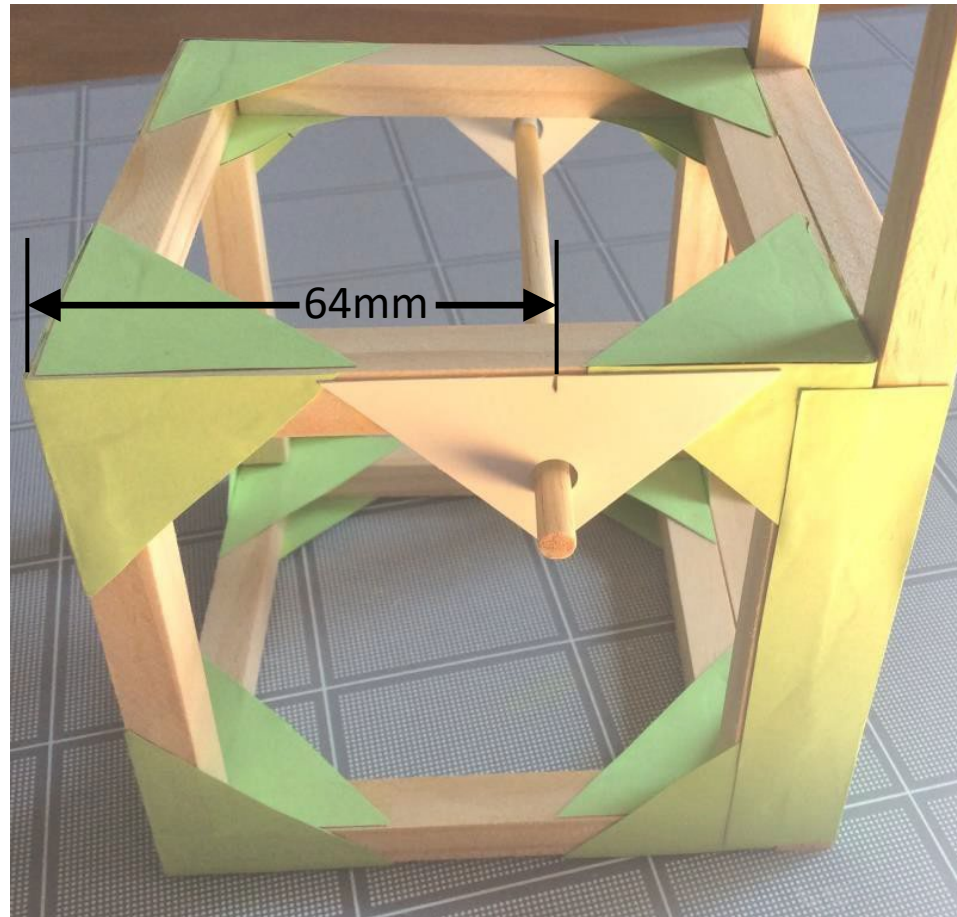

Add axle holders to inside of frame

Glue two more axle holders on the inside edges as shown to reinforce the axle. Make sure the holes line up



Glue axle holders to the uprights

Glue an axle holder onto the outside of each upright so that the centre of the hole is 38 mm from the top of the upright and the hole points towards the cube. Once the axle is horizontal and perpendicular to the uprights, glue two more axle holders on the inside

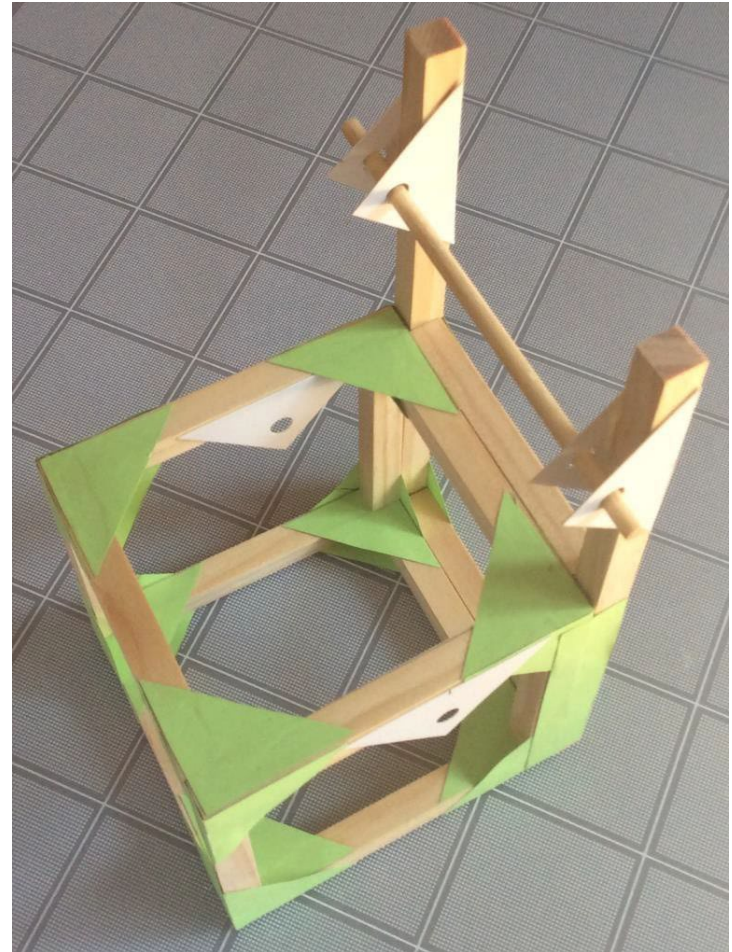

Make piston-syringe platform

Glue together three 25mm pieces of wood using glue between the pieces. Glue two axle holders to opposite sides and trim to be flush with the wood. This is the platform that will hold the white syringe holder of the piston-syringe that moves the arm.

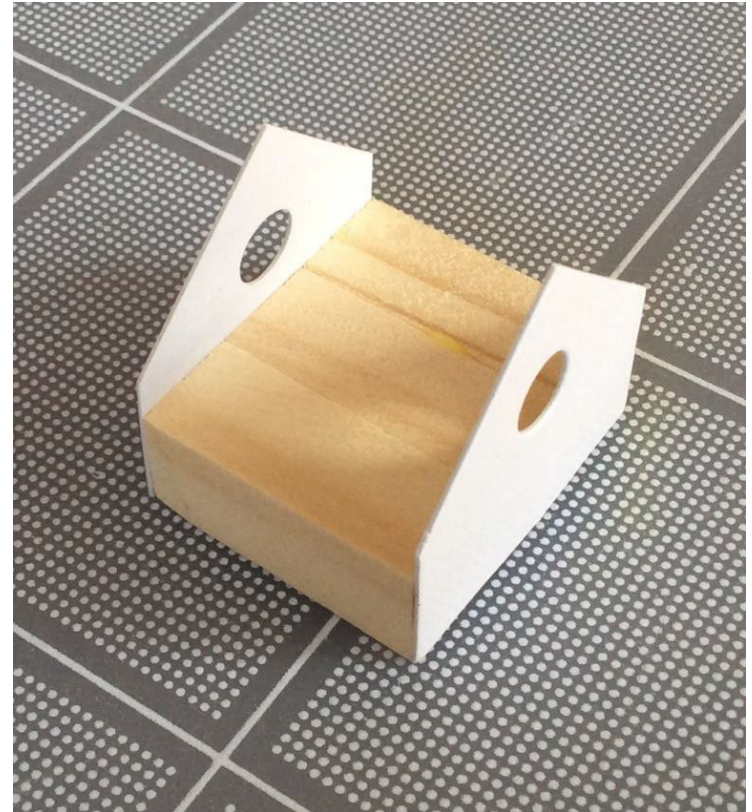
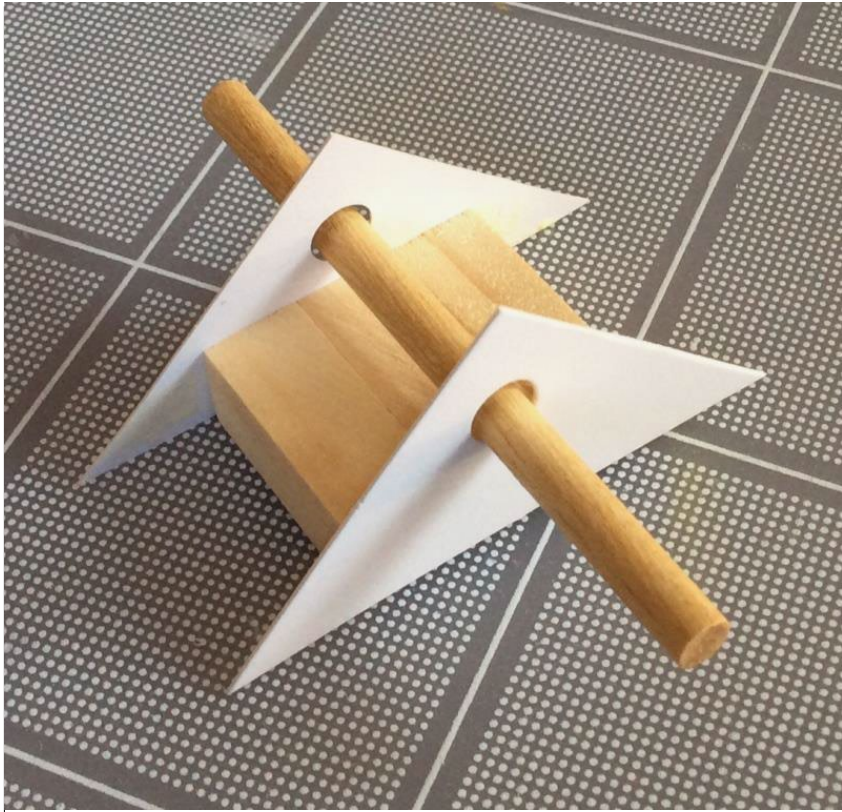

Test structure with piston-syringe axle installed

Once everything is dry, install a longer axle holding the piston-syringe support in the structure and test to ensure smooth rotation.



Make the lifter arm

Connect two 203mm pieces and two 38mm pieces. Use eight corner gussets – four on each side.

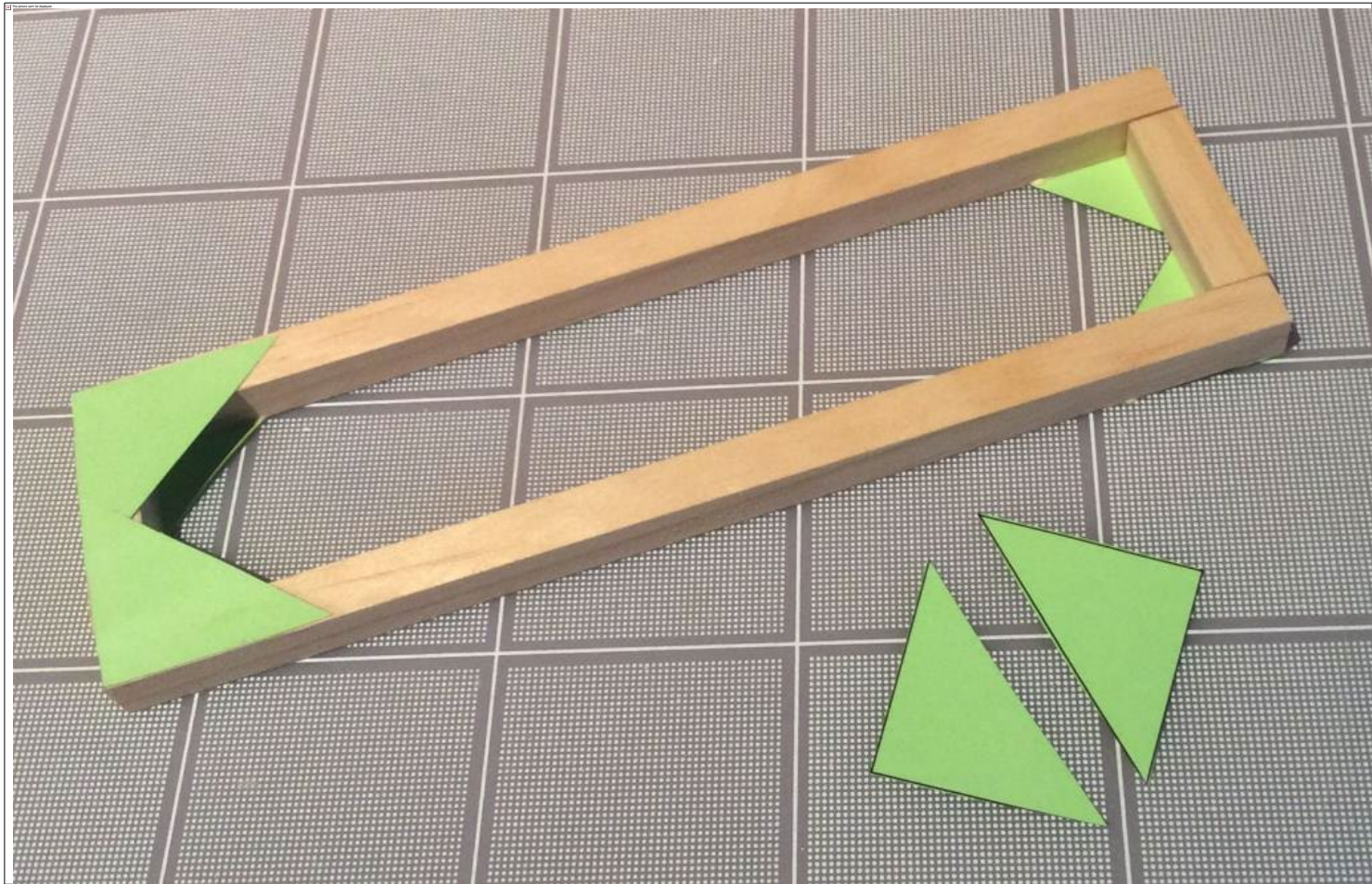

Installing axle holders on the lifter arm

On this frame glue an axle holder in place so that its smallest angle touches the corner of the frame. Use a long axle to align and glue another axle holder on the outside of the opposite side. Test that the long axle sits across the frame parallel to the shortest end.

Finish by gluing a second set of white axle holders in place as shown.

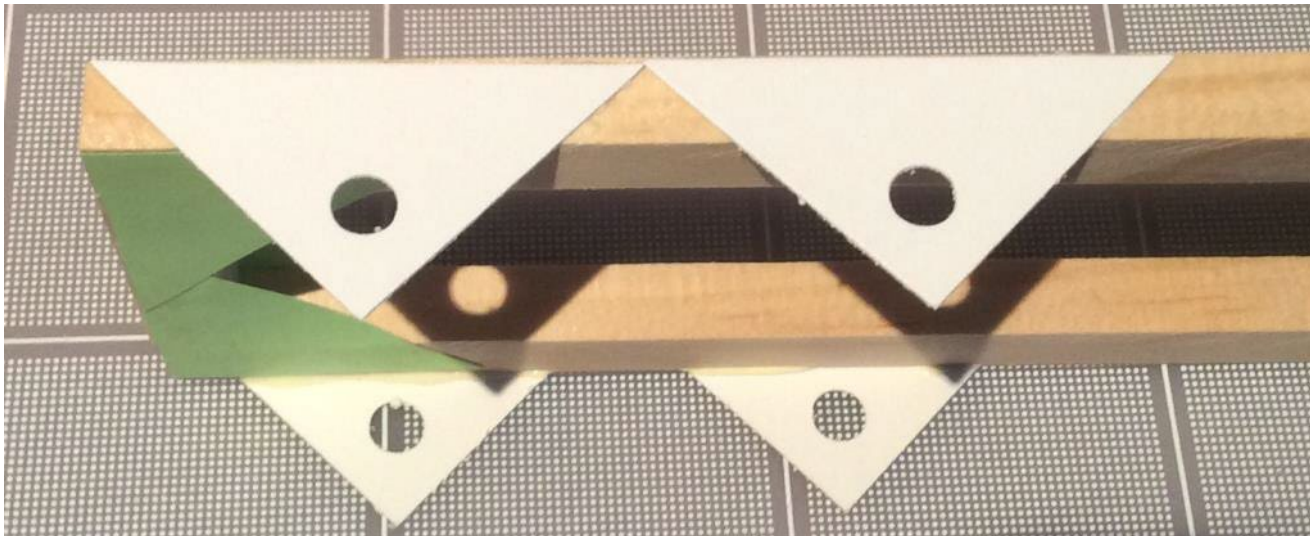
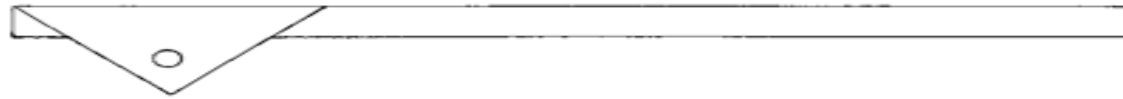

Add axle holders and axles

Align and glue in place two more axle holders on the inside of the frame. Install the axles to confirm that they rotate smoothly in the axle holders.

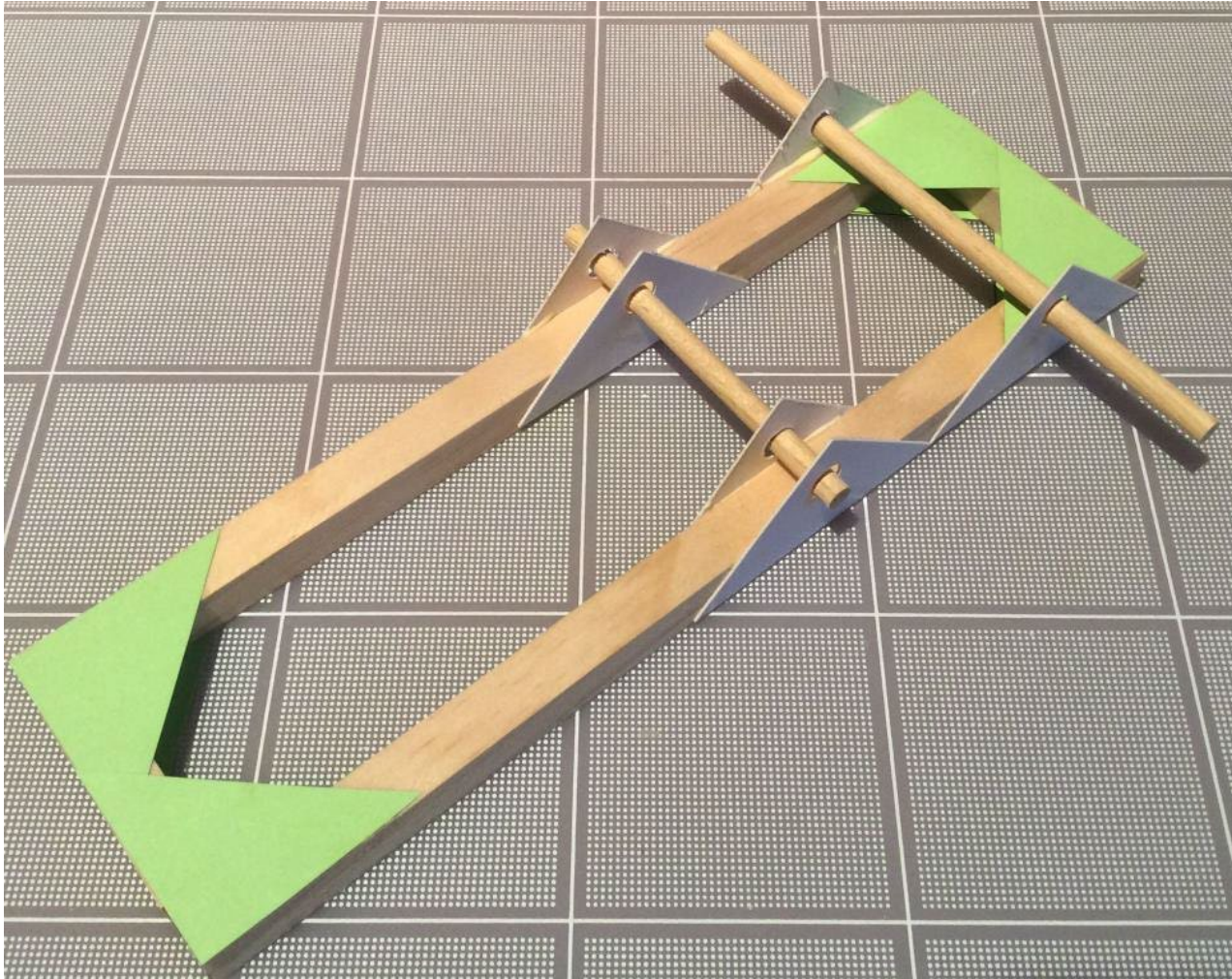

Adding the syringe to the lifter arm

Identify the syringe that has a hole drilled in its plunger. The 76mm axle fits through this hole and should turn in it. If it sticks a little, use the round file or sandpaper to make it larger. The axle and plunger fit between the double axle holders on the arm. The axle protruding outside the lifter arm frame is secured using a mini-washer on each end.

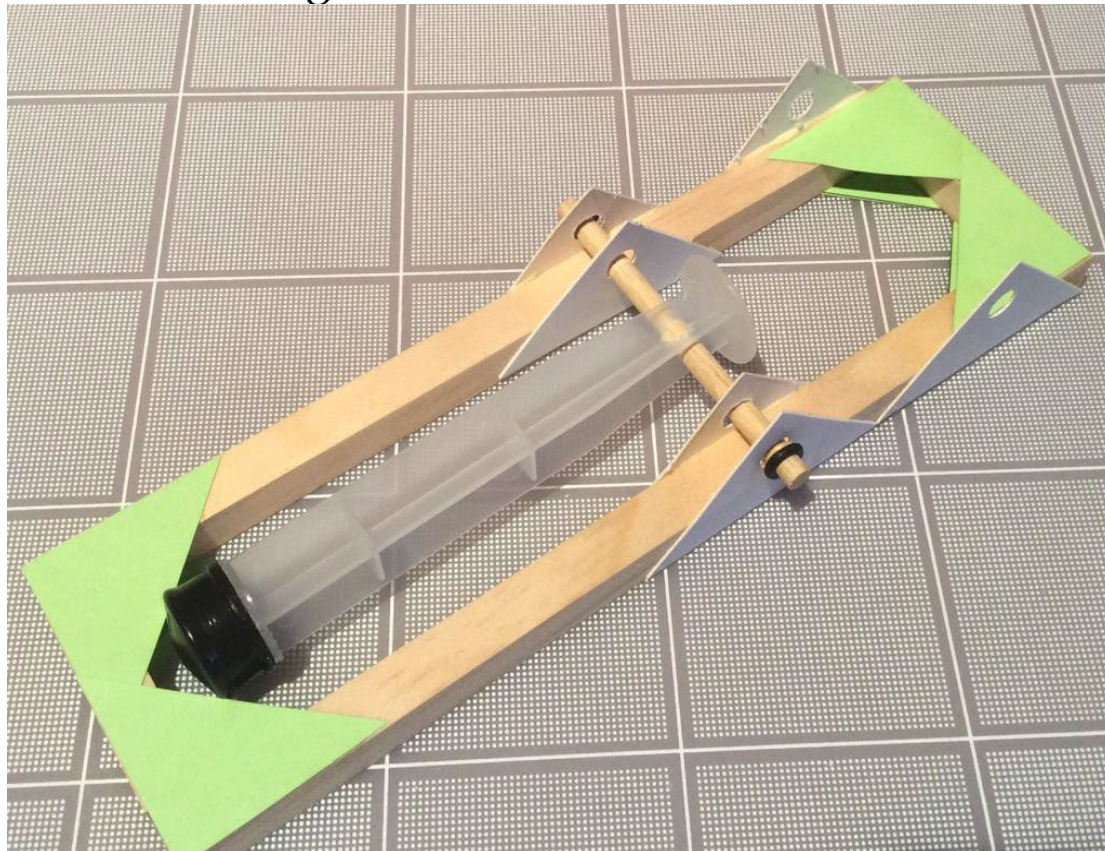

Attach the syringe holder to the syringe platform

Strip the backing from the white piston syringe holder and press it firmly onto the previously made platform



Assemble the syringe and the platform

Place the barrel of the syringe into the clip so that the clip aligns with the 15 ml mark or thereabouts. Be careful to orientate the barrel lip as shown



Add the syringe to the structure

Insert the syringe platform into the structure so the lip points toward the long uprights and the plunger is above the axle as shown below. Secure with four mini-washers, two securing the syringe platform and two securing the axle ends on the outside of the structure.

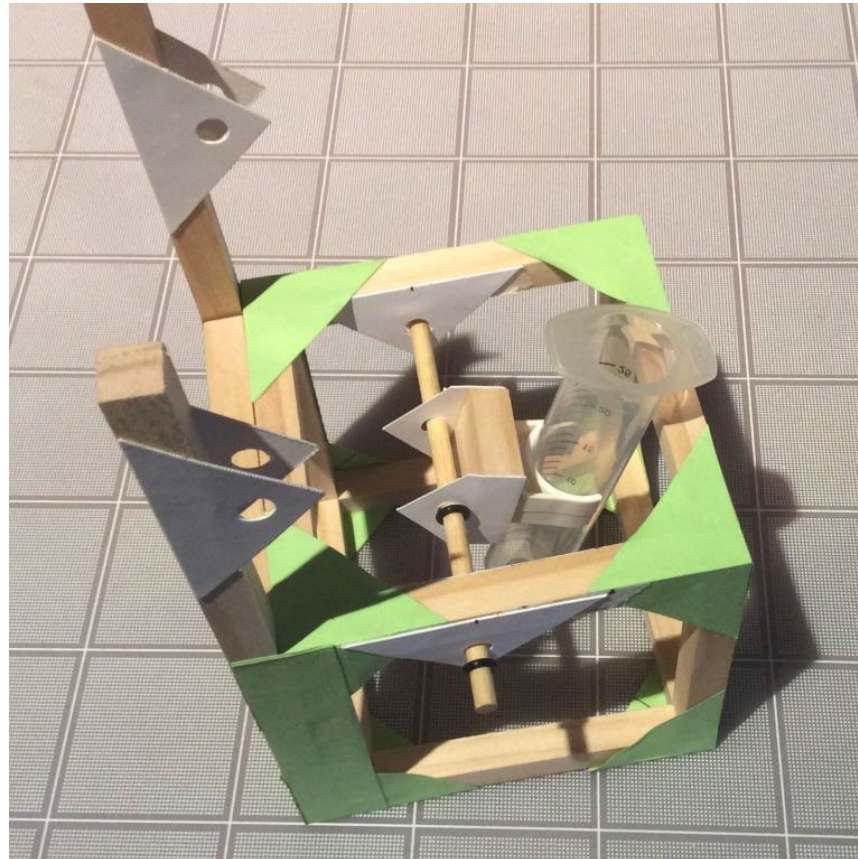

Add the lifter arm to the structure.

Carefully insert the plunger into the barrel of the syringe until the holes at the end align with the holes in the axle holders glued to the uprights on the structure. Once aligned, carefully insert the 127mm axle through all six holes. The axle is secured with a mini-washer at each end.

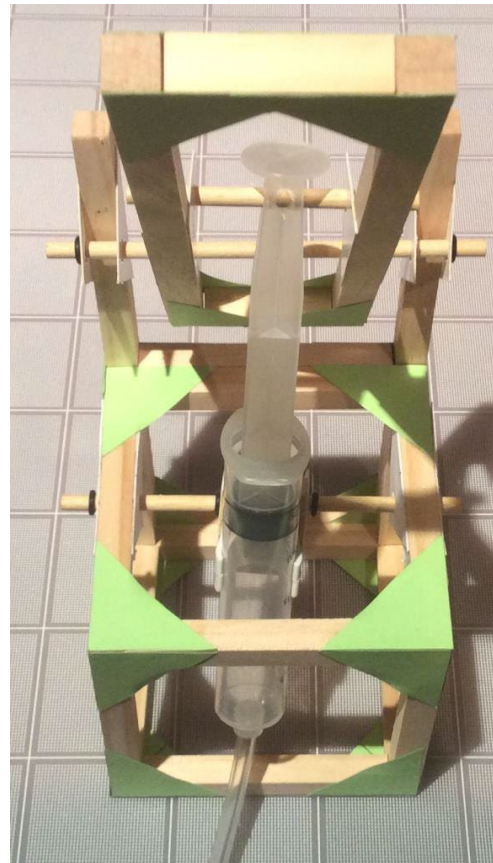

Axle through all six holes

Connect the syringes with tubing & test the lifter operation

To operate the mechanism attach the length of plastic tubing to the end of the acting syringe that is now housed in the structure. The other syringe should be fully extended before it is connected to the other end of the tubing. Gently push the plunger down. This syringe drives the acting syringe and the arm will move up.

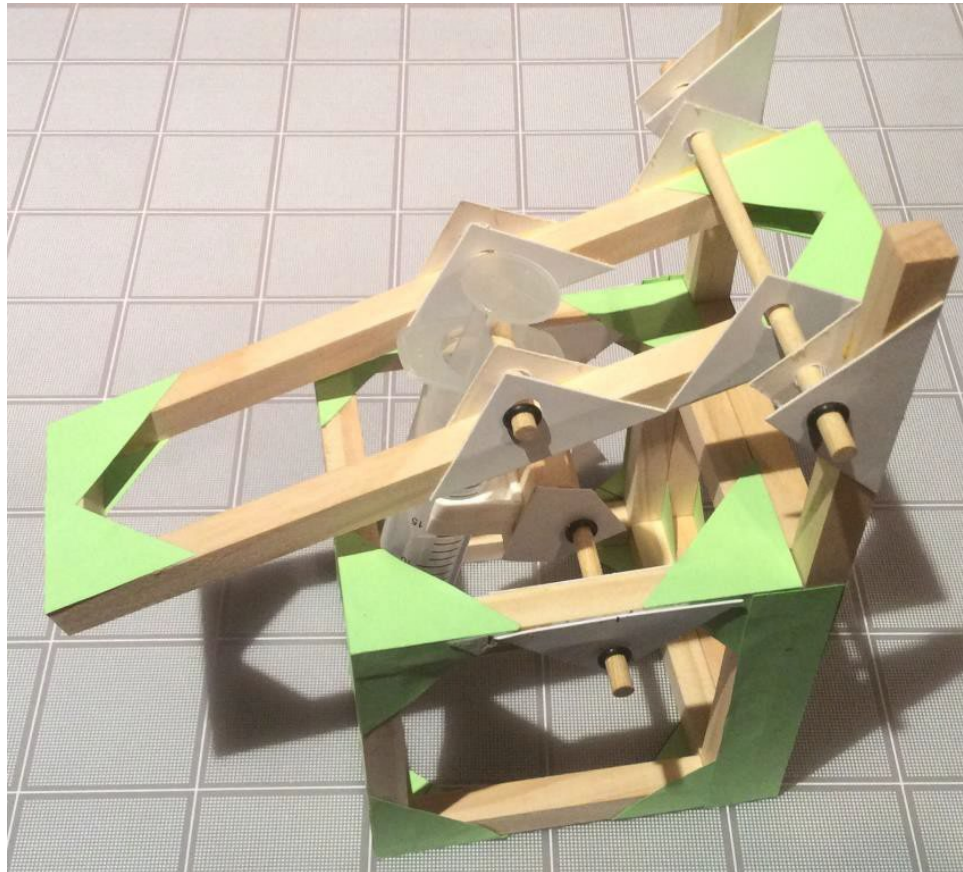

Lifter closed

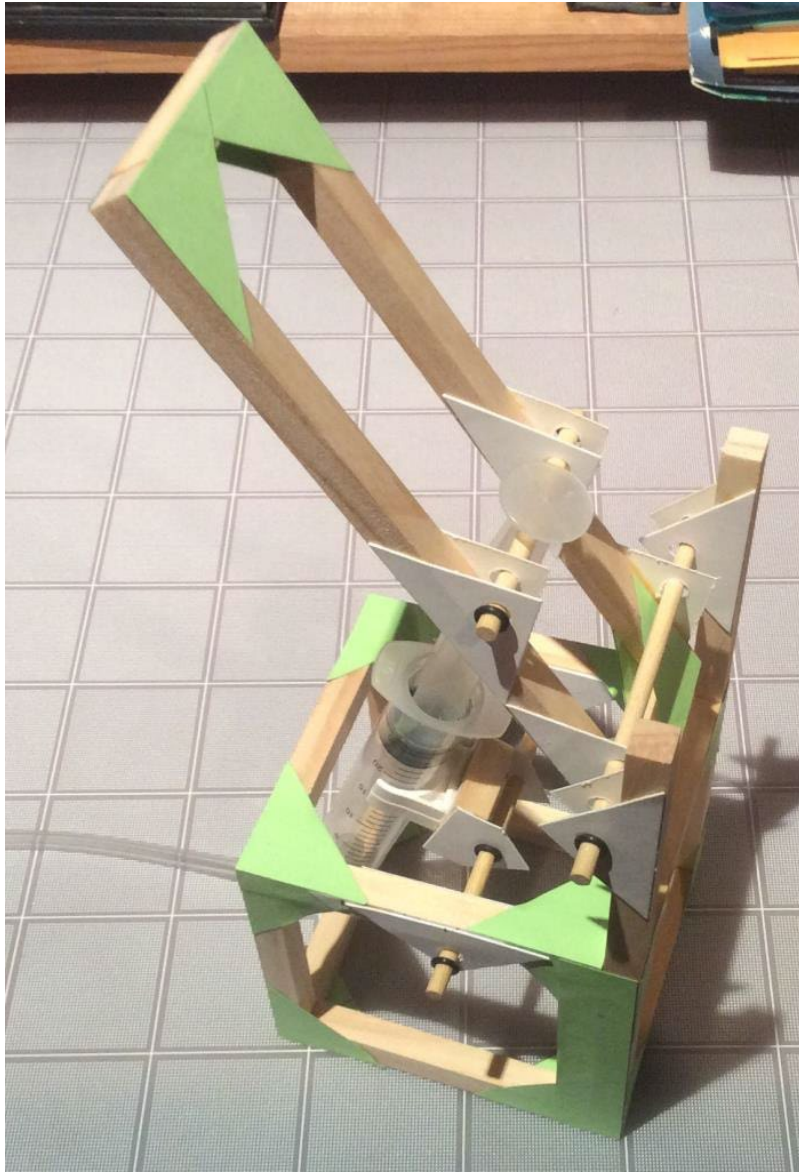

Lifter open

THE NUMBER #1 REASON THE CLIP TEARS FROM ITS BASE

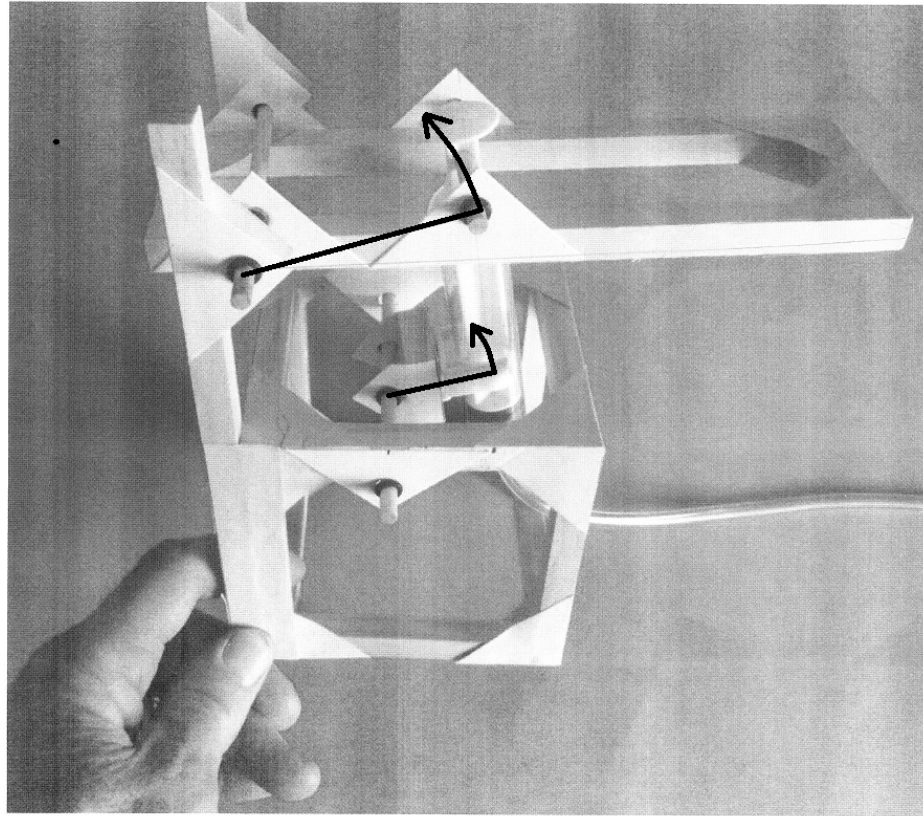

As the arm turns so must the platform it is mounted on!